

Unvented water heaters

Pioneers, innovators and market leaders in efficient unvented water heating



EXCELSIOR®



Designed and manufactured in the UK



Excelsior

Specification guide

Product construction - typical

Immersion heater	☞ 3kw, 240V, 1ph, Incoloy 825, with thermostat incl. cut-out
Thermal insulation	☞ CFC/HCFC free, (ODP=0, GWP=1), 60mm fire retardant insulation*
Outer casing	☞ P200 Plastisol
Inner cylinder	☞ Duplex stainless steel
Heating coil	☞ High performance, finned
Indirect thermostat	☞ Twin thermostat with independent reset, 30-70°C
Safety device	☞ Factory fitted with 7bar/90°C pressure & temperature relief valve
Connections	☞ Secondary return on 175L & above

* 50mm on 400L and 500L vessels



Product specification

Inlet diffuser	☞ For optimal blending of cold & hot water, see fig. 1
Expansion	☞ WXI - 3 bar internal expansion with  Technology, the self-sustaining air-gap system <i>All other ranges - 3 bar external expansion</i>
Pressure test	☞ Tested to 10 bar
Secondary return	☞ Standard fit on models 175L & above
Approvals	☞ BBA, CE, WRAS, KIWA, ISO, WRC
Guarantee	☞ Internal cylinder 25 years* Ancillary components 1 year
Direct thermostat	☞ Element thermostat, nominal setting 60°C
Indirect model	☞ 22mm diameter stainless steel high performance coil & outlet with 1 immersion heater
Direct model	☞ 80L fitted with 1 immersion heater; 130 - 500L fitted with 2 immersion heaters
Manufacturing	☞ All UK using state-of-the-art robot technology
Horizontal & Slimline	☞ Suitable for roof voids & 450mmØ specification
Renewables range	☞ Solar, heat pump and buffer vessels

* Commercial cylinders carry 5 years guarantee

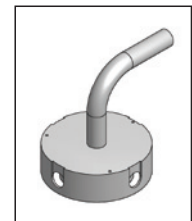



Fig.1

Features & Benefits

Specifier/builder features	Installer benefits	Consumer benefits
1 Duplex stainless steel	No sacrificial anode	Low maintenance
2 UK designed & manufactured	Local support	Spares and service back up
3 Butt welded joints	Eliminates corrosion	Long cylinder life
4 Inlet diffuser	Maximises hot water	Maximises hot water
5 High performance heating coil	Fast re-heat times	Constant hot water
6 Minimal heat loss	60mm insulation with outer casing	Lower energy use
7 High flow rates	No shower pumps	Fast filling baths
8 Balanced hot & cold water	Mains pressure to all outlets	High performance showering
9 Pre-plumbed available	Ease of installation	Minimal disruption
10 Twin or triple coil available	Suits all heat sources	Useable with solar or heat pumps
11 Excelsior with  Technology	Reduces installation time	Maintenance-free
12 Hi-Flo Excelsior with  Technology	Suits large domestic/commercial	Higher flow rates with 3S technology

Excelsior

Heating performance

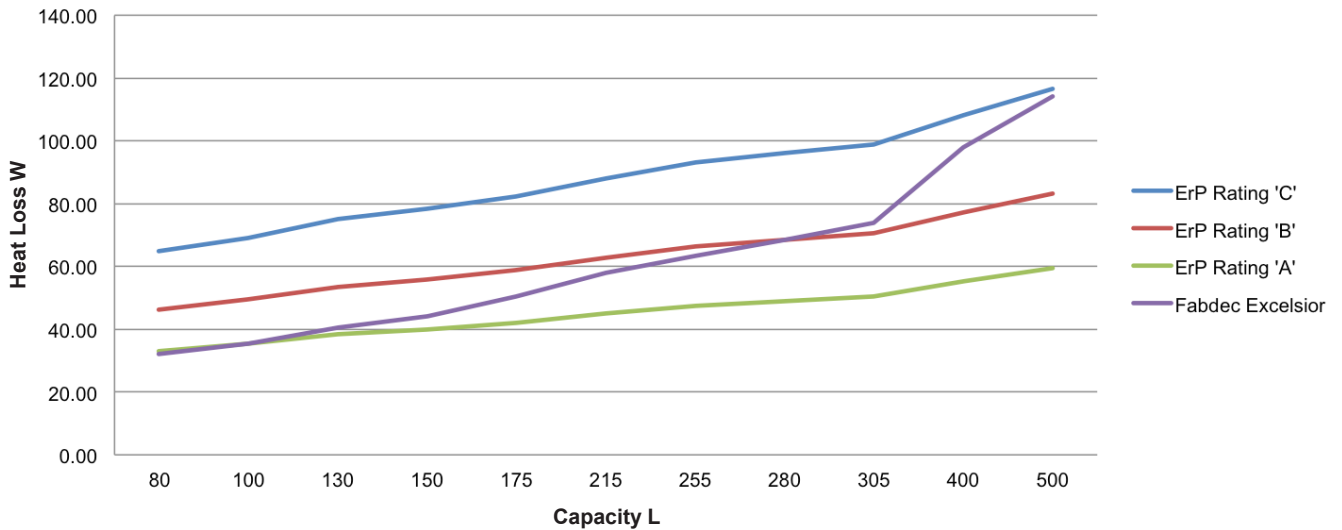

Vessel	Direct			Indirect		Coils (kW)		Weight (kg)		Weight (kg) Full	
	Standing Heat Loss (kW/24h)	Reheat time after 70% draw off*	Time to heat from cold to 65°C*	Reheat time after 70% draw off*	Time to heat from cold to 65°C*	Primary	Direct	Indirect	Direct	Indirect	
80L	0.77	71	102	15	21	14.6	25	30	105	110	
100L	0.85	80	110	17	24	14.6	27	32	127	132	
130L	0.97	83	115	20	27	14.6	30	35	160	165	
150L	1.06	109	123	22	31	14.6	35	40	185	190	
175L	1.21	131	148	21	31	20	40	45	215	220	
215L	1.39	157	182	26	37	20	45	50	260	265	
255L	1.52	191	229	29	42	20	50	55	305	310	
280L	1.64	210	245	32	44	20	53	58	333	338	
305L	1.77	228	261	34	46	20	55	60	360	365	
400L	2.35	220	340	40	57	27	65	68	465	468	
500L	2.74	326	425	55	71	27	75	78	575	578	

* Time (minutes)

** Vessel	Solar Direct			Solar Indirect		Coils (kW)		Weight (kg)		Weight (kg) Full	
	Standing Heat Loss (kW/24h)	Reheat time after 70% draw off*	Time to heat from cold to 65°C*	Reheat time after 70% draw off*	Time to heat from cold to 65°C*	Aux / Boiler Coil	Primary	Solar Direct	Solar Indirect	Solar Direct	Solar Indirect
130L	-	16	20	-	-	14.6	20	35	40	165	170
150L	-	19	23	-	-	14.6	20	40	45	190	195
175L	-	14	20	14	20	20	27	45	50	220	225
215L	-	17	24	17	24	20	27	50	55	265	270
255L	-	20	29	20	29	20	27	55	60	310	315
305L	-	24	34	24	34	20	27	60	65	365	370

* Time (minutes)

Excelsior WXI

Excelsior with technology

Current issues with expansion in unvented water heaters:

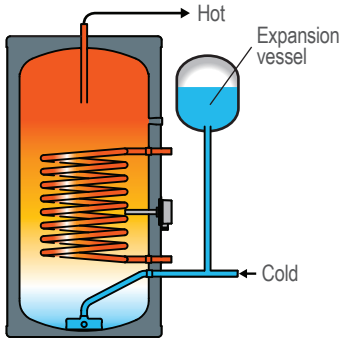

External expansion

- ✗ Bulky, has more parts, requires more space
- ✗ Requires longer on-site installation
- ✗ Needs replenishment

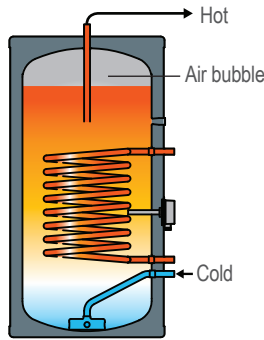

Internal expansion

- ✗ Integrated air bubble
- ✗ Needs frequent replenishment
- ✗ Takes only low pressure

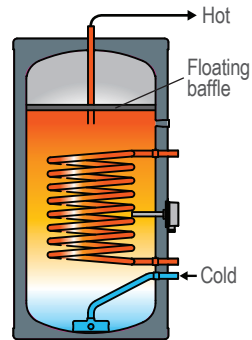

Protected Internal expansion

- ✗ Integrated air bubble
- ✗ Protected with a plastic baffle
- ✗ Could need replenishment as baffle seal is not fully 100%

How 3S technology works:

3S technology uses fluid dynamics to create negative pressure known as the 'Venturi effect'. With precision design this configuration draws enough air to recharge the air gap as the tank is filled and requires no future maintenance - a truly *self-sustaining system*:

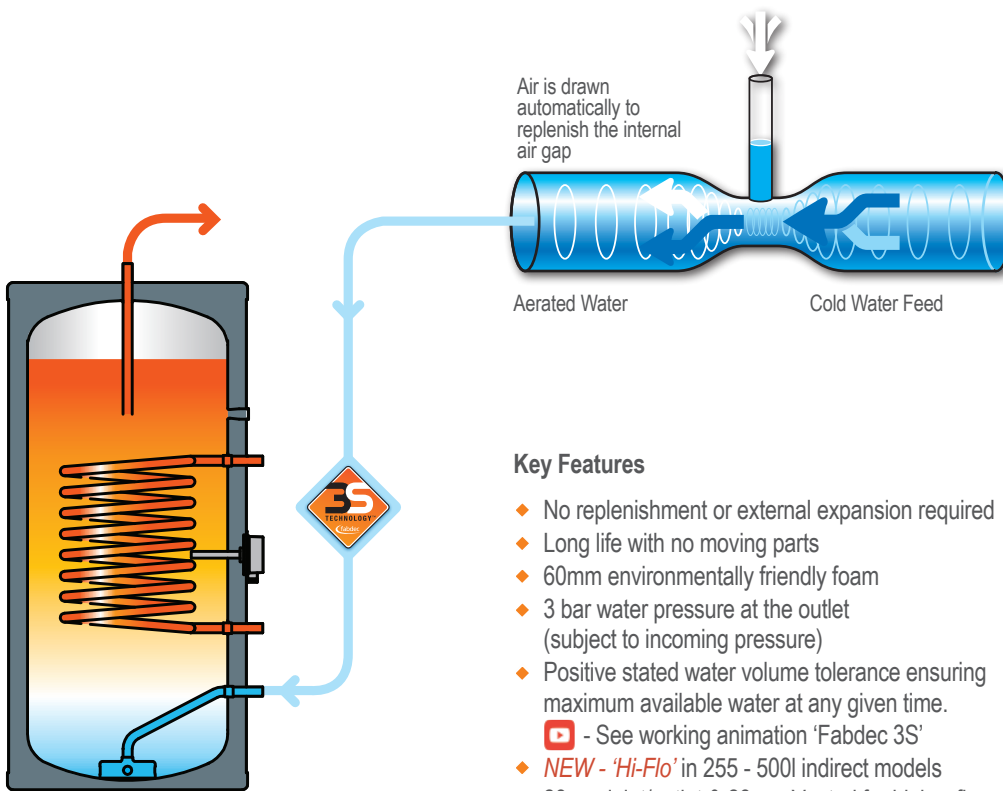

Key Features

- ◆ No replenishment or external expansion required
- ◆ Long life with no moving parts
- ◆ 60mm environmentally friendly foam
- ◆ 3 bar water pressure at the outlet (subject to incoming pressure)
- ◆ Positive stated water volume tolerance ensuring maximum available water at any given time.
- ▶ - See working animation 'Fabdec 3S'
- ◆ **NEW** - 'Hi-Flo' in 255 - 500l indirect models
- ◆ 28mm inlet/outlet & 28mm Venturi for higher flow rates



Excelsior WXI

Excelsior with technology

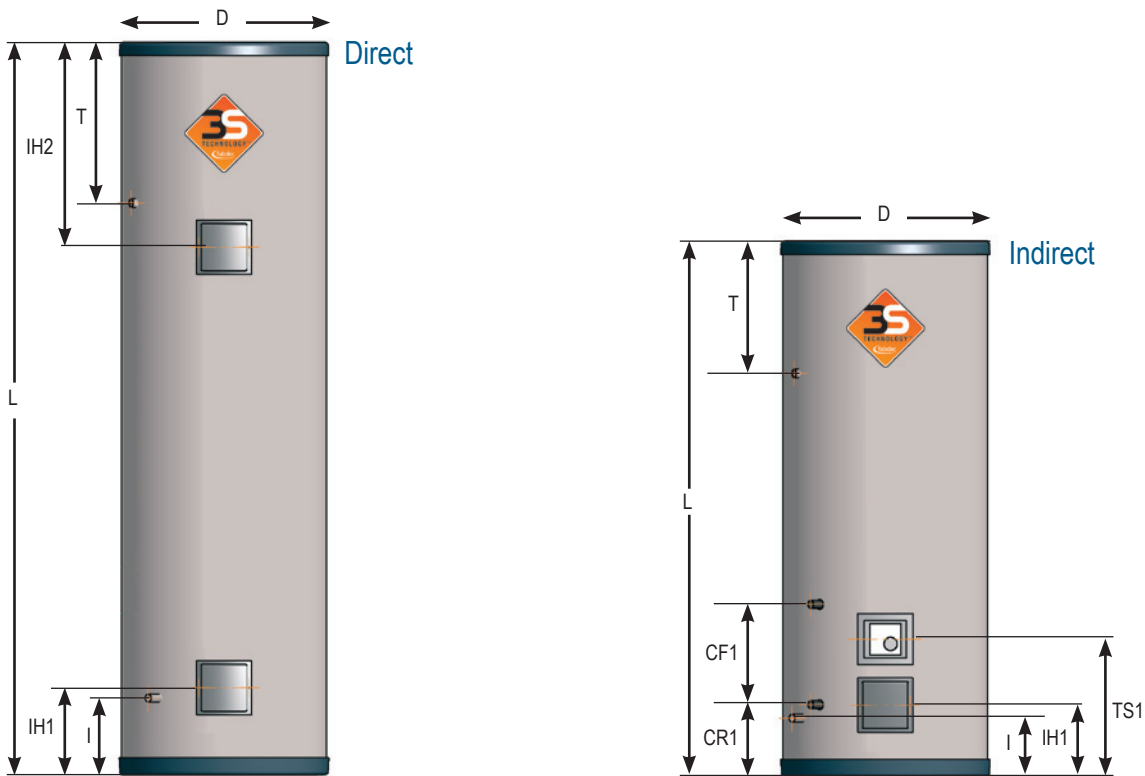

Direct with 3S internal expansion (self-sustaining air-gap system)

Size	L	D	I	T	IH1	IH2
80L	703	576	182	222	196	-
100L	860	576	182	318	196	457
130L	1043	576	182	331	196	540
150L	1235	576	182	395	196	613
175L	1370	576	182	507	196	673
215L	1666	576	182	550	196	754
255L	1884	576	182	550	196	780
280L	2028	576	182	588	196	875
300L	2150	576	182	560	196	847
400L	1522	756	220	460	235	657
500L	1896	756	220	495	235	891

Indirect with internal expansion (self-sustaining air-gap system)

Size	L	D	I	T	IH1	CR1	CF1	TS1	Coil Rating
80L	703	576	182	222	196	213	88	246	14.6kW
100L	860	576	182	318	196	213	88	246	14.6kW
130L	1043	576	182	331	196	213	193	358	14.6kW
150L	1235	576	182	395	196	213	193	358	14.6kW
175L	1370	576	182	507	196	213	263	380	20.0kW
215L	1666	576	182	550	196	213	263	380	20.0kW
255L*	1884	576	182	550	196	213	263	380	20.0kW
280L*	2028	576	182	588	196	213	263	380	20.0kW
300L*	2150	576	182	560	196	213	263	380	20.0kW
400L*	1522	756	220	460	235	250	250	373	27.0kW
500L*	1896	756	220	495	235	250	250	373	27.0kW

* These vessels are also available with 28mm diameter stainless steel inlet & outlet for high water flow

Excelsior WDE

With external expansion

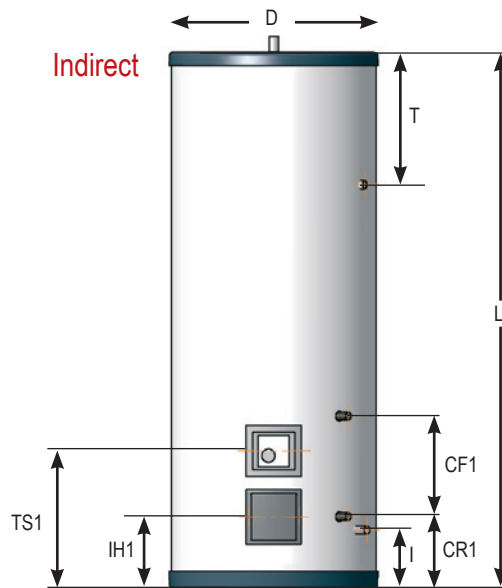
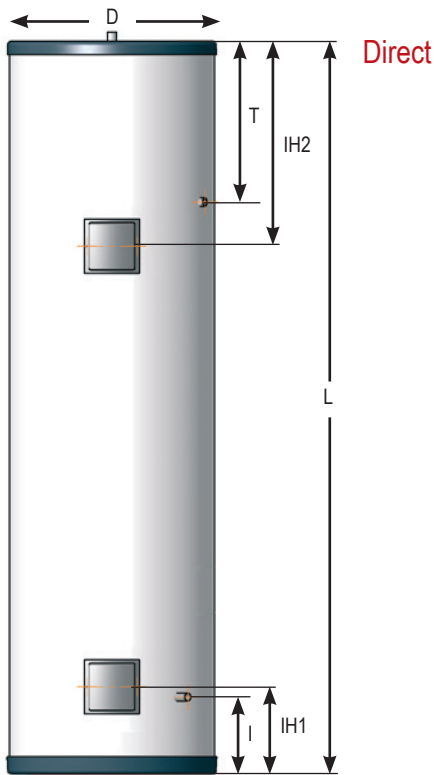

Direct with 3 bar external expansion

Size	L	D	I	T	IH1	IH2
80L	665	576	182	222	196	N/A
130L	957	576	182	222	196	454
150L	1085	576	182	222	196	463
175L	1242	576	182	222	196	545
215L	1484	576	182	222	196	572
255L	1752	576	182	222	196	648
305L	2028	576	182	222	196	725
400L	1405	756	220	262	235	515
500L	1690	756	220	262	235	660

Indirect with 3 bar external expansion

Size	L	D	I	T	IH1	CR1	CF1	TS1	Coil Rating
80L	665	576	182	222	196	213	88	246	14.6kW
130L	957	576	182	222	196	213	193	358	14.6kW
150L	1085	576	182	222	196	213	193	358	14.6kW
175L	1242	576	182	222	196	213	263	380	20.0kW
215L	1484	576	182	222	196	213	263	380	20.0kW
255L	1752	576	182	222	196	213	263	380	20.0kW
305L	2028	576	182	222	196	213	263	380	20.0kW
400L	1405	756	220	262	235	250	245	373	27.0kW
500L	1690	756	220	262	235	250	245	373	27.0kW

Excelsior WS

Solar range

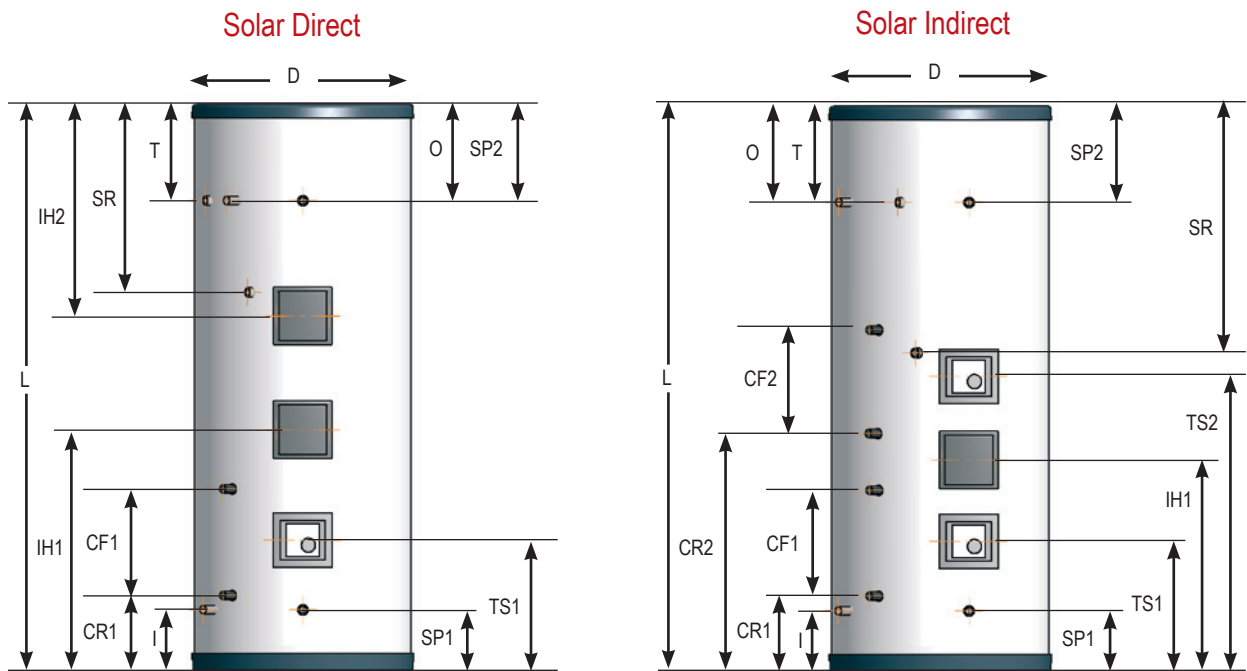

Solar Direct with external expansion

Size	L	D	I	T	CR1	CF1	SP1	TS1	IH1	SR	IH2	SP2	O	Solar Coil Surface Area*	Solar Volume
130L	958	578	183	226	213	193	183	297	454	325	349	226	226	0.75m ²	56L
150L	1086	578	183	226	213	193	183	297	509	340	402	226	226	0.75m ²	56L
175L	1243	578	183	226	213	267	183	344	584	473	402	226	226	1.1m ²	69L
215L	1485	578	183	226	213	267	183	337	587	665	476	226	226	1.1m ²	69L
255L	1753	578	183	226	213	267	183	337	587	665	476	226	226	1.1m ²	69L
305L	2029	578	183	226	213	267	183	337	587	665	476	226	226	1.1m ²	69L

Solar Indirect with external expansion

Size	L	D	I	T	CR1	CF1	SP1	CR2	CF2	TS1	IH1	SR	SP2	TS2	O	Solar Coil Surface Area*	Aux Coil Surface Area*	Aux Coil Rating	Solar Volume
130L	958	578	183	226	213	193	183	504	193	297	454	325	226	612	226	0.75m ²	0.54m ²	14.6kW	56L
150L	1086	578	183	226	213	193	183	504	193	297	454	340	226	612	226	0.75m ²	0.54m ²	14.6kW	56L
175L	1243	578	183	226	213	267	183	578	263	345	530	473	226	715	226	1.1m ²	0.75m ²	20.0kW	69L
215L	1485	578	183	226	213	267	183	582	263	337	530	591	226	715	226	1.1m ²	0.75m ²	20.0kW	69L
255L	1753	578	183	226	213	267	183	582	263	337	530	665	226	715	226	1.1m ²	0.75m ²	20.0kW	69L
305L	2029	578	183	226	213	267	183	582	263	337	530	665	226	715	226	1.1m ²	0.75m ²	20.0kW	69L

Innovative hot water outlet to reduce thermal losses.

*Other coil sizes available upon request.

Excelsior WT

Slimline Direct / Indirect range

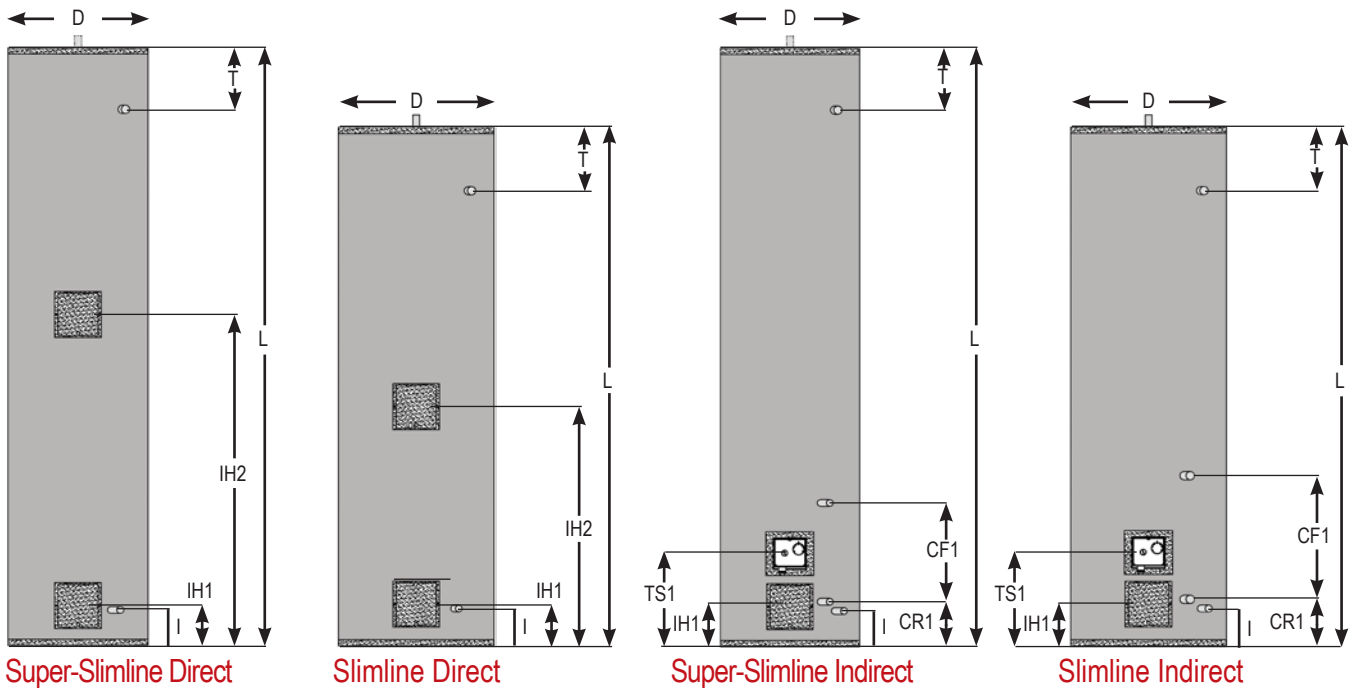

Slimline Direct with external expansion							Slimline Indirect with external expansion									
Size	L	D	I	T	IH1	IH2	Size	L	D	I	T	IH1	CR1	CF1	TS1	Coil Rating
100L	1044	515	179	207	193	550	100L	1044	515	179	207	193	209	320	360	14.6kW
130L	1326	515	179	207	193	643	130L	1326	515	179	207	193	209	320	360	14.6kW
150L	1466	515	179	207	193	682	150L	1466	515	179	207	193	209	320	360	14.6kW
175L	1738	515	179	207	193	832	175L	1738	515	179	207	193	209	400	360	20.0kW
210L	2010	515	179	207	193	1008	210L	2010	515	179	207	193	209	400	360	20.0kW

Super-Slimline Direct with external expansion							Super-Slimline Indirect with external expansion									
Size	L	D	I	T	IH1	IH2	Size	L	D	I	T	IH1	CR1	CF1	TS1	Coil Rating
80L	1110	462	165	200	179	-	80L	1110	462	165	200	179	195	320	351	14.6kW
100L	1344	462	165	200	179	664	100L	1344	462	165	200	179	195	320	351	14.6kW
130L	1716	462	165	200	179	850	130L	1716	462	165	200	179	195	320	351	14.6kW
150L	1935	462	165	200	179	1122	150L	1935	462	165	200	179	195	320	351	14.6kW
165L	1998	462	165	200	179	1221	165L	1998	462	165	200	179	195	400	395	20.0kW

SLIMLINE and SUPER-SLIMLINE vessels are also available with Coil/s in RENEWABLES configuration. Please enquire.

Excelsior WZ

Horizontal vessels



Horizontal Direct

Size	A
130L	957
150L	1085
175L	1242
215L	1484
255L	1752
305L	2028

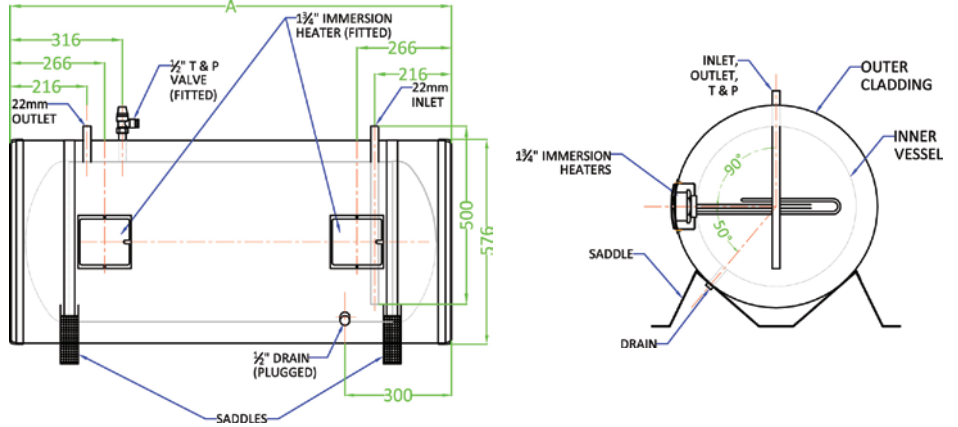

Horizontal Indirect

Size	A	B	C	Aux Coil m ²
130L	957	478	298	0.54
150L	1085	543	363	0.54
175L	1242	621	371	0.75
215L	1484	742	492	0.75
255L	1752	876	626	0.75
305L	2028	1014	769	0.75

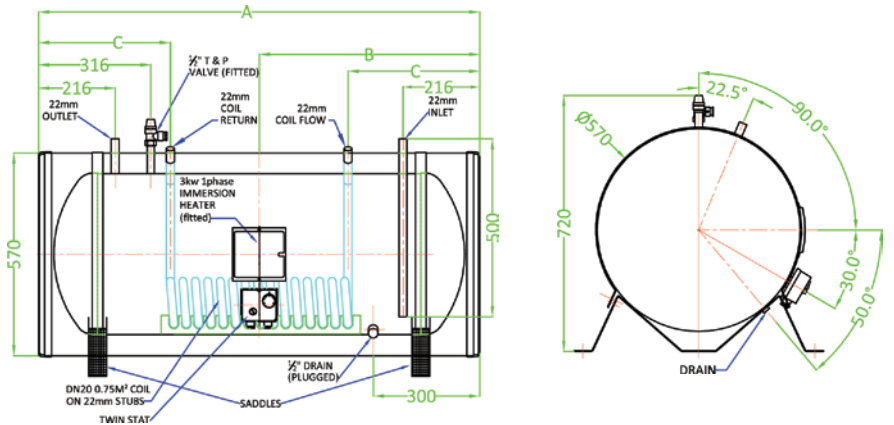

Horizontal Twin Coil

Size	A	B	C	D	Solar Coil m ²	Aux Coil m ²
150L	1085	543	363	293	0.75	0.54
175L	1242	621	371	301	1.1	0.75
215L	1484	742	492	422	1.1	0.75
255L	1752	876	626	556	1.1	0.75
305L	2028	1014	769	594	1.1	0.75

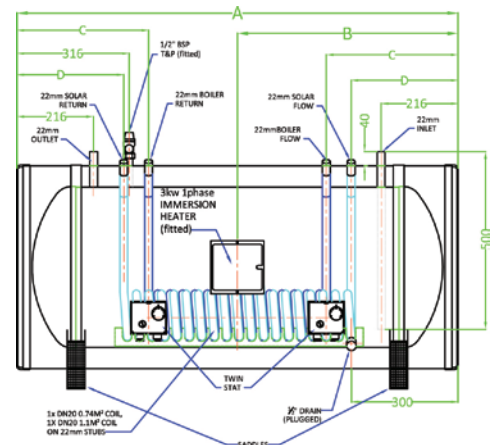

Excelsior WHP

Heat Pump range

Heat Pump Single Coil

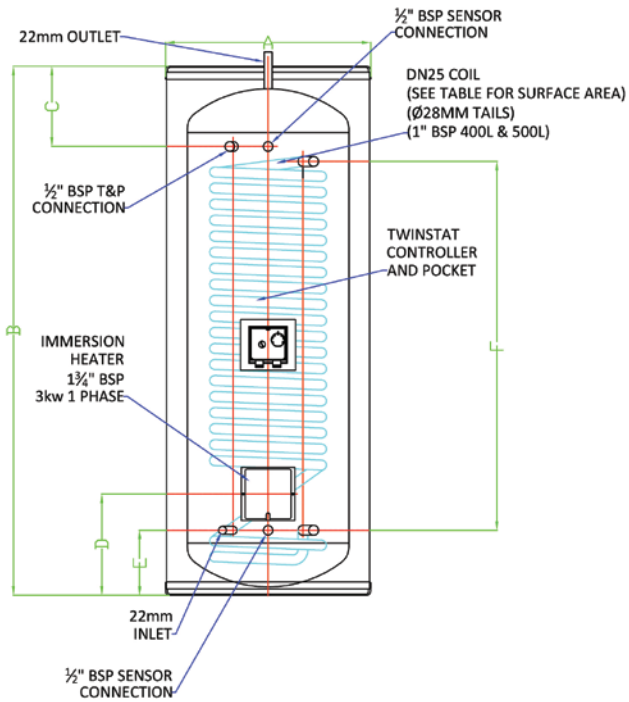

Heat Pump Twin Coil

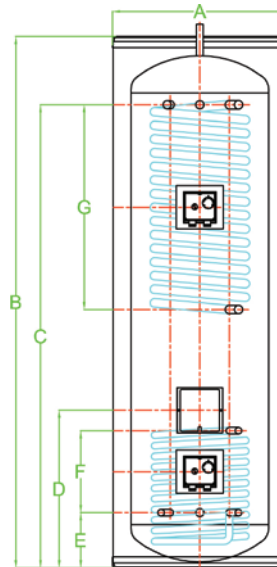

Heat Pump single coil with external expansion

Size	A	B	C	D	E	F	HP Coil Surface Area*
150L	575	1085	225	284	182	678	2m ²
175L	575	1242	225	284	182	720	2m ²
215L	575	1485	225	284	182	1035	3m ²
255L	575	1752	225	284	182	1035	3m ²
305L	575	2028	225	284	182	1035	3m ²
400L	750	1405	262	303	228	495	4m ²
500L	750	1690	262	303	228	495	4m ²

Heat Pump twin coil with external expansion

Size	A	B	C	D	E	F	G	HP Coil Surface Area*	Solar Coil Surface Area
215L	575	1485	1259	520	182	270	675	2m ²	1.1m ²
255L	575	1752	1527	520	182	270	675	2m ²	1.1m ²
305L	575	2028	1800	520	182	270	675	2m ²	1.1m ²
400L	750	1430	1196	655	276	315	480	3m ²	1.1m ²
500L	750	1715	1481	655	276	315	720	4m ²	1.1m ²

Standard coil inlet and outlet diameter 28mm (DN25)

Other vessel sizes available upon request.

*Other coil sizes available upon request.

Excelsior WI & WB

Commercial & Buffer Vessels

The high performance and design values of the Excelsior vessel can also be obtained in a commercial/bespoke format, now with 90mm insulation (ODP=0, GWP=1).

These vessels can be built to the requirements of the specifier; with connection bosses, coils, inlets, outlets, pockets and ancillary equipment all located and sized to your specification.

Connection Bosses

☞ Size & location

Coils

☞ Length
Materials
Surface area
Positioning

Inlets / Outlets

☞ Size & location

Pockets (eg: temperature sensor)

☞ Size & location

Ancillary equipment

☞ Expansion kits, gauges, pumps etc...

Water heating vessels are available up to 10,000 litres & buffer/storage vessels up to 32,000 litres.

Design service available on request.

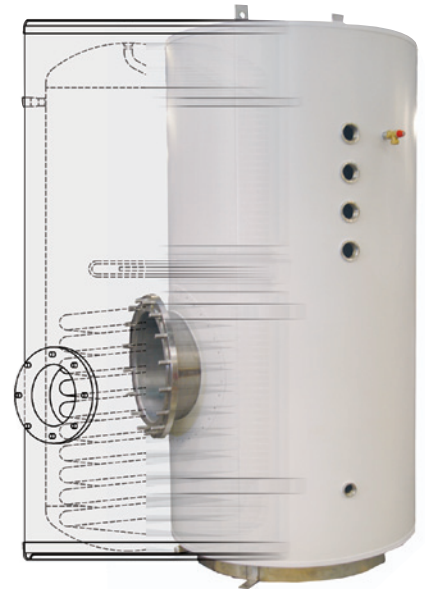

Commercial Vessels

Size	A	B	4	6	8	Coil Rating
450L	750	1565	1"	1"	Ø28	27kW
500L	750	1720	1"	1"	Ø28	27kW
680L	750	2250	1"	1"	Ø28	54kW
840L	750	2745	1½"	1½"	Ø28	54kW
965L	1080	1850	1½"	1½"	Ø28	54kW
1125L	1080	2100	1½"	1½"	Ø28	54kW
1380L	1180	2120	1½"	1½"	Ø28	54kW
1775L	1180	2620	1½"	1½"	Ø28	54kW
1875L	1380	2050	2"	2"	Ø28	54kW
2155L	1380	2332	2"	2"	Ø28	54kW

Description

- | | |
|---|---|
| 1 | Auxiliary (½" BSP) connection |
| 2 | Auxiliary (½" BSP) connection |
| 3 | Auxiliary (½" BSP) connection |
| 4 | Inlet (1", 1½", 2" BSP) connection |
| 5 | Immersion Heater (2 ¼" BSP) connection |
| 6 | Outlet (1", 1½", 2" BSP) connection |
| 7 | Temperature & Pressure Relief Valve (¾" BSP) connection |
| 8 | Coil Connections (Upper and Lower) |

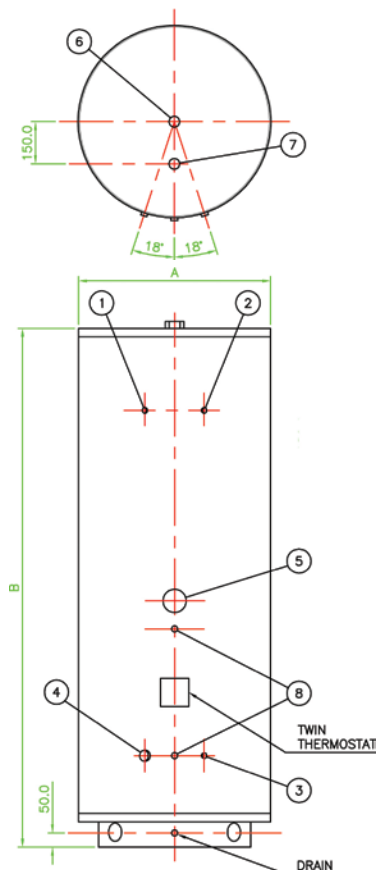

Also from Fabdec:



Pre-plumb



- 175l - 500l indirect
- Two heating zones standard
- Integrated Venturi - no need to add expansion vessel
- Pre-wired



- A comprehensive range of water heating spares

www.fabdec.com/water

Fabdec Ltd
Grange Road
Ellesmere
Shropshire
SY12 9DG

Tel: +44 (0) 1691 627200
Fax: +44 (0) 1691 627222
Email: sales@fabdec.com



Fabdec 3S

Accreditation:



ISO 9001
Certificate No. GB2005138



CIPHE Industrial Associate

Water heating systems